

PVC-U System

# *Spectus* Bevelled Windows and Doors



**Epwin**<sup>TM</sup>  
window systems

# An understated design classic

The Spectus Bevelled System has been the PVC-U system of choice for homeowners, builders and architects throughout the UK for more than two decades.

The understated clean and traditional aesthetics of the Spectus Bevelled System deliver a versatile match for any window or door style, offering a combination of product flexibility with cutting-edge system design. Add in the broad range of colour and finish options and the widest range of ancillaries in the business to perfect all projects, and you have an impressively versatile combination.



## A system that's made in Britain

The Spectus Bevelled System is designed for the British market with intelligent product features that are suitable for all British properties. It's made in Britain too, which gives us control over our supplies, their sources and their quality, as well as helping us to reduce transport emissions.



## A system that delivers outstanding manufacturing quality

The Spectus Bevelled System is manufactured and finished in our state-of-the-art facilities using some of the world's most advanced tooling and sophisticated machinery. Add in the scale of our operation and warehousing facilities and it means you have a partner able to offer the strength and reliability your business needs.



## A system renowned for investment in continuous development

The Spectus Bevelled System remains at the forefront of PVC-U system design. It's because our skilled designers and technical teams continually listen to feedback and track the market in order to develop innovations that ensure the system continues to lead the way in everything from performance and sustainability to lifespan.



## A system that's backed with value-added service and support

The Spectus Bevelled System has a pedigree that can only come from a business with the size and scale of Epwin Window Systems. It also comes with a level of service and support innovation that takes your business forward. It's a compelling combination that gives your business a competitive edge.





## A truly British heritage

The Spectus Bevelled System is produced by Epwin Window Systems, the UK's largest systems house with a track record stretching back nearly 50 years.

We offer the widest portfolio of fully integrated window and door systems, a choice of leading brands, with unrivalled expertise and support to grow your business.

We firmly believe in continuous investment in our production facilities and operations. Our approach means we are able to provide the levels of quality and reliability you have a right to expect.

Our products are designed and manufactured in Britain for the British market. We are active in trade and industry bodies and we take a leading stance in environmental initiatives. Our commitments mean you are able to rely on us to be a proactive partner that adds value to your business.

Because when you work with Epwin Window Systems you get more options and more possibilities.

**MADE IN  
BRITAIN** 



# Exceptional benefits

## Spectus Bevelled System

The Spectus Bevelled System offers an exceptional combination of benefits that combine to deliver a system that's both a design classic and a cutting-edge statement.



### Sleek aesthetics

The Spectus Bevelled System offers crisp lines and slimline elegance.

These combine with equal frame and bead sightlines to create a clean aesthetic.

It's a fully integrated system that gives you a complete range of products while the comprehensive range of ancillaries are all designed to work perfectly together and provide an immaculate finish.



### Impressive performance

The Spectus Bevelled System has been designed to meet all minimum standards – and offer the flexibility to create solutions that meet precise performance requirements up to Band 'A+' WER and U-values to 0.8 W/m<sup>2</sup>K.

There are five glazing sizes (24mm, 28mm, 36mm, 40mm and 44mm) and triple glazed options with 40mm and 44mm glazing.

The 5-chamber system increases thermal performance while the large reinforcement chambers give optimum strength under wind load parameters.



## Clever design

Everywhere you look, the Spectus Bevelled System is packed with clever design features.

Drainage paths are carefully positioned for efficient routing. Co-extruded gaskets save time, eliminate corner gaps and reduce 'shrink back'.

The profiles are designed so reinforcing can be inserted quickly and easily while location lugs allow welding with reinforcement in place.

Installers will appreciate the equal sash to frame overlaps across all products, which gives a consistent rebate cavity and allows a good choice of hardware, as well as the knock-in beads that enable speedy installation and easier glazing.



# Spectus Casement Window System

The classic window choice.

The Spectus Bevelled Casement Window is a perennial favourite thanks to its clean lines and almost endless versatility. It is suitable for almost any size or layout of casement window and includes all the components for bay & bow windows and conservatories too.



## Product features

- 1 Deep bevelled design
- 2 24, 28, 36, 40 & 44mm glazing options
- 3 Optional RCM inserts available
- 4 5-chamber sash & outer frame
- 5 85, 110, 150, 180, 225mm cill options

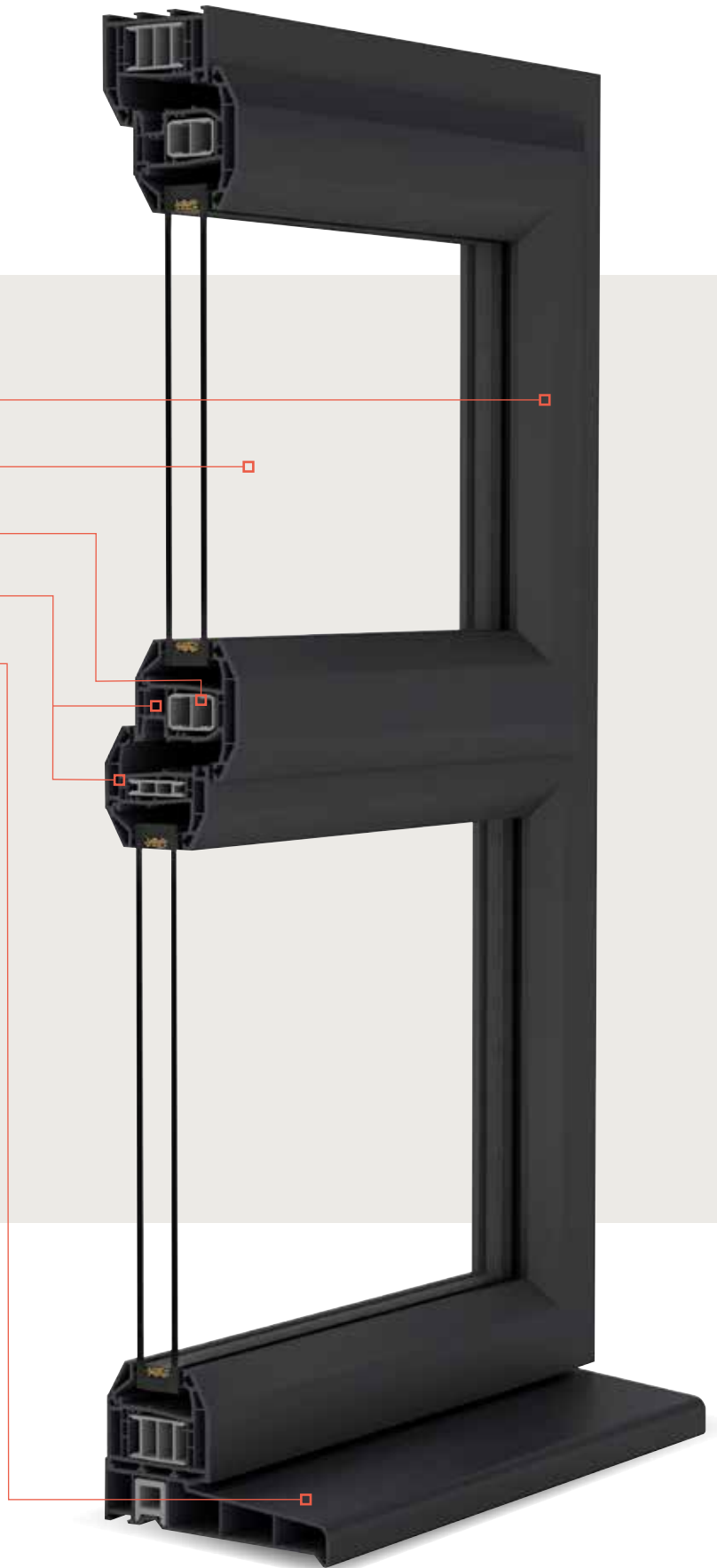



# Spectus French Casement Window System

Ideal for recreating traditional timber window designs.

The Spectus Bevelled French Casement Window can be used for French-style and double opening casements or where traditional timber styling is needed. Unlike a traditional casement window, the French Casement Window doesn't have a central mullion. This means it provides unobstructed views and enhanced ventilation when open.

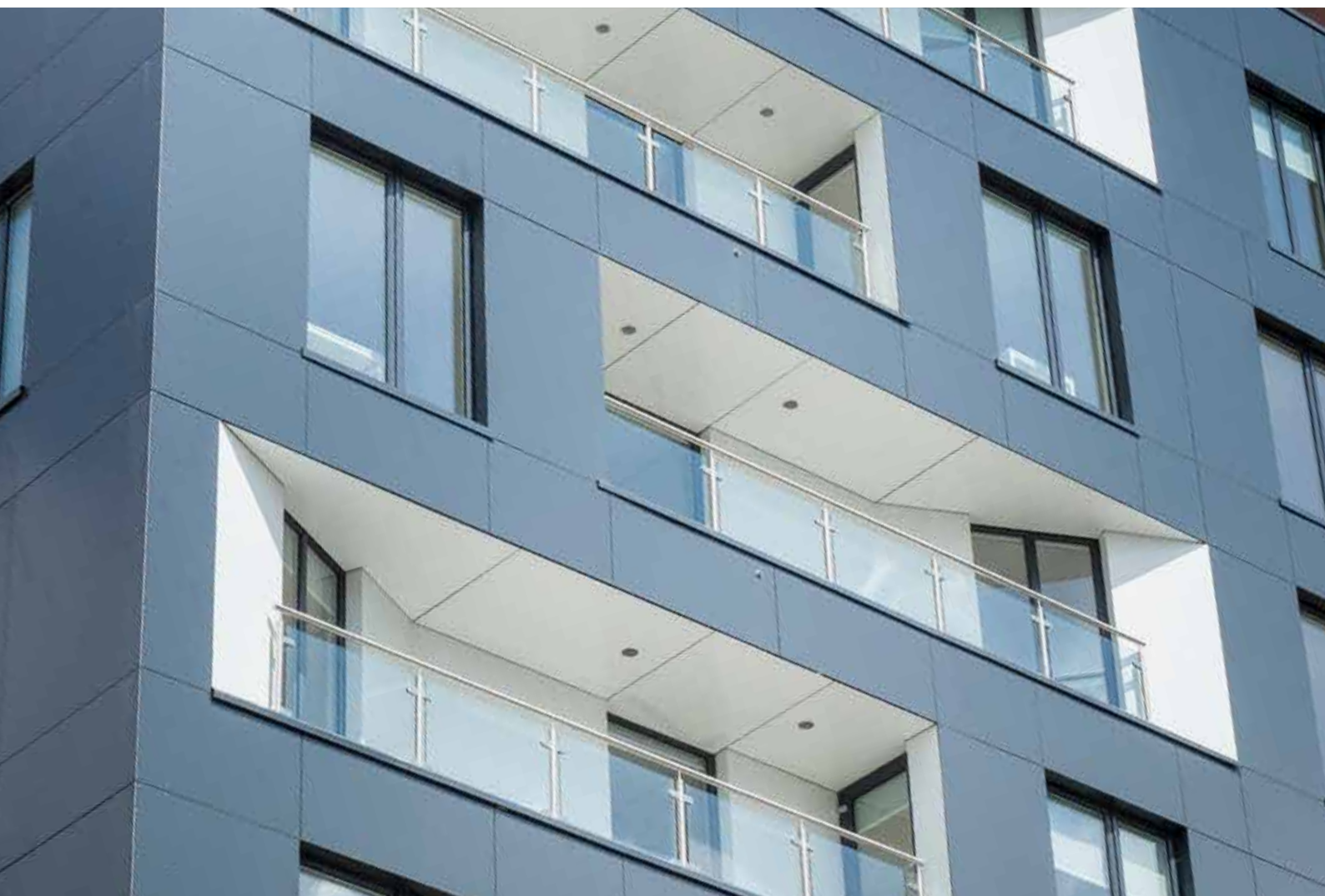



## Product features

- 1 Deep bevelled design
- 2 24, 28, 36, 40 & 44mm glazing options
- 3 Optional RCM inserts available
- 4 5-chamber sash & outer frame
- 5 85, 110, 150, 180, 225mm cill options

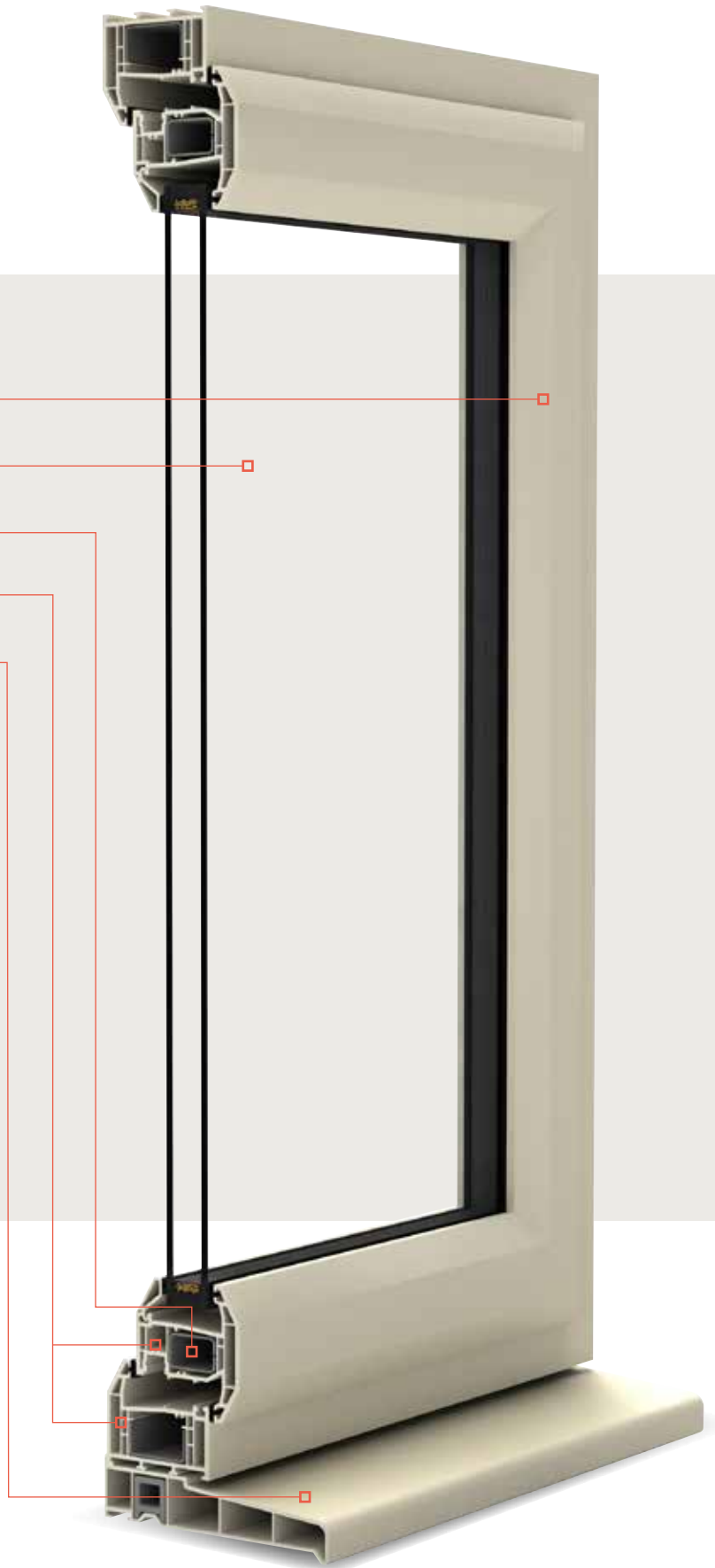

# Spectus Tilt & Turn Window System

The perfect high-rise window solution.

The Spectus Bevelled Tilt & Turn Window has crisp styling that makes it perfect for commercial projects or anywhere a clean aesthetic is required. It is ideal for high-rise or difficult to access locations because both sides of the window can be safely cleaned from the inside. It has been engineered to make it easy to operate, as well as secure, thermally efficient and weather tight.



## Product features

- 1 Deep bevelled design
- 2 24, 28, 36, 40 & 44mm glazing options
- 3 5-chamber sash & outer frame
- 5 85, 110, 150, 180, 225mm cill options

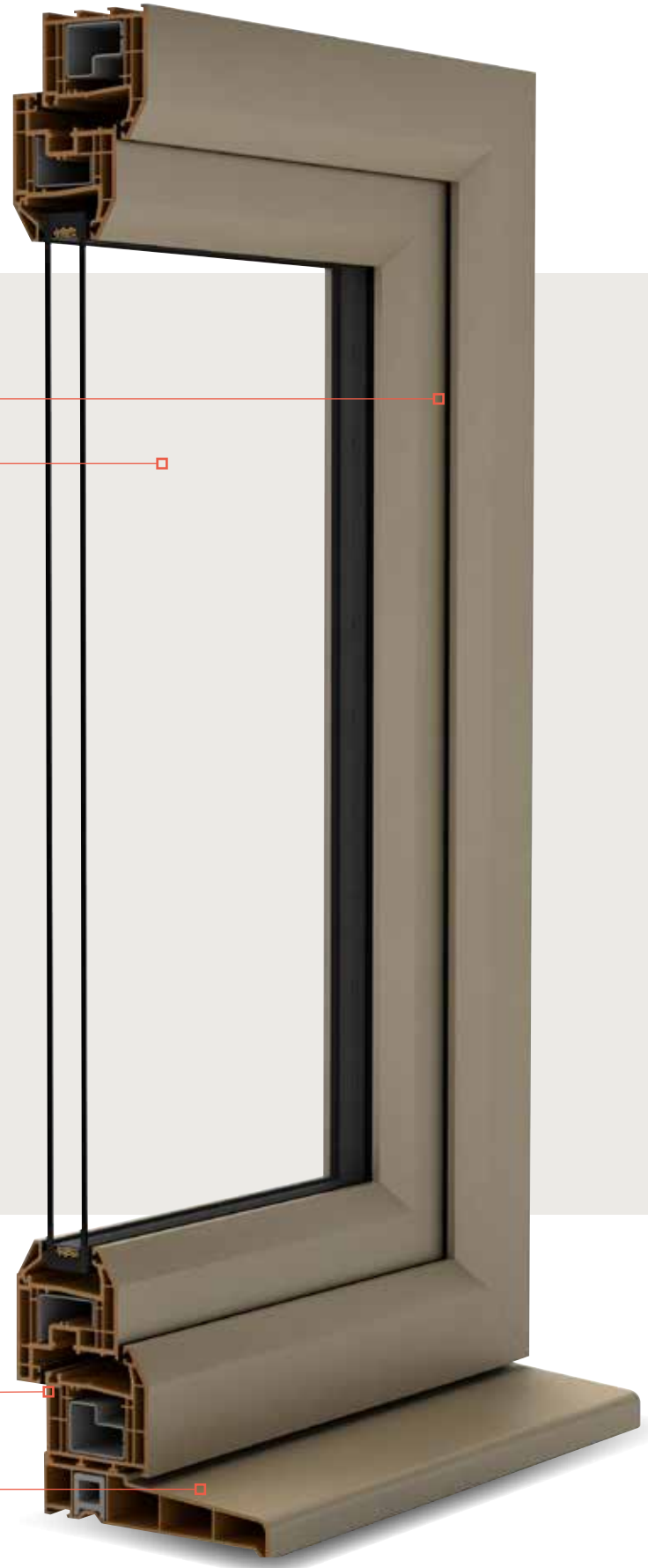



# Spectus Residential and French Door System

Complete a seamless project.

Alongside our Spectus Bevelled window collection there is a range of residential and French doors. They are packed with the same high-quality benefits as the window system and are suitable for all types of project. They give you the products you need to create a streamlined, seamless project that adds value and delivers impressive results.



## Product features

- 1 Deep bevelled design
- 2 24, 28, 36, 40 & 44mm glazing options
- 3 5-chamber sash & outer frame
- 4 Part M compliant

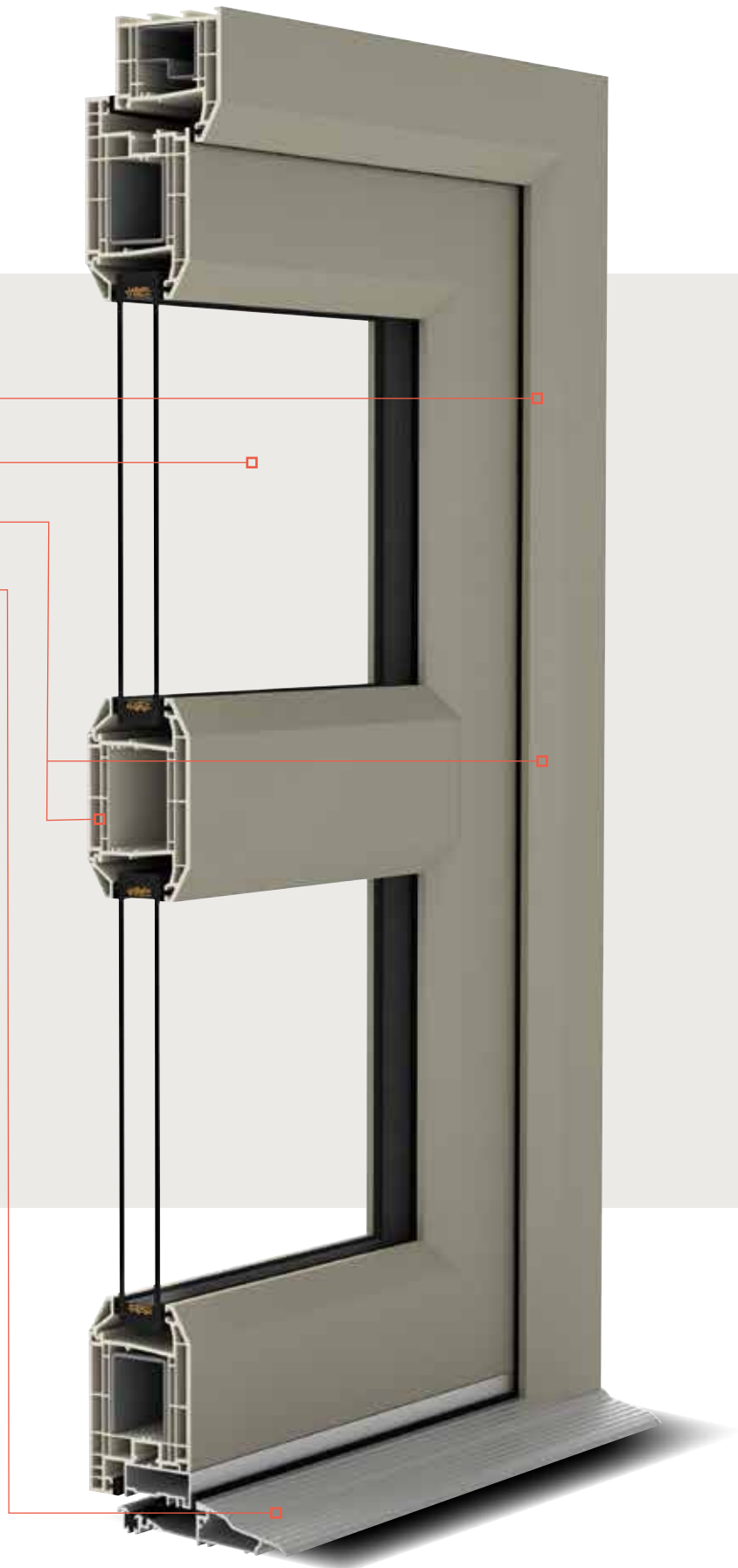

# Ancillaries

More ancillaries than any other system.

Thanks to our extensive range of ancillaries, the Spectus Bevelled System offers outstanding versatility. All our PVC-U ancillaries are guaranteed to colour match our main systems and are available in the same extensive choice of coloured and woodgrain foils. It all means that with the Spectus Bevelled System you can achieve a perfect project every time.

## Thermal Inserts

Specifically designed for the Spectus Bevelled System, our thermal inserts are made from 100% recycled PVC-U. They are lightweight, easy and safe to work with, long lasting and highly insulating. Used together with traditional steel or aluminium reinforcements, the inserts have been designed to improve screw retention and ensure perfect hardware positioning. They work with sashes, transoms and mullions and all sizes of outer frame. There's even an insert for use in door outer frames, which has a significantly increased wall thickness to support hinges and keeps.



## Two-Part Cill

The Two-Part Cill is a simple yet effective adaptation that's the smart answer to fitting cills in high-traffic construction sites. The two-step process allows you to fit the cill receiver as part of the construction process and add the cill nose when the project nears completion. Available in 150mm and 180mm sizes, in a range of colours, the Two-Part Cill is the smart solution to eliminating damaged cills during construction.







## Bays and Couplings

The range includes dedicated bay posts and poles, bay jacking, assemblies, coupling mullions and finishing trims. It means you can create any shape or component you need.



## Extruded Ancillaries

The cill range runs from 85mm to 225mm. Frame packers are available at 15mm, 20mm, 35mm and 50mm. Also available are Eurogroove covers, head drips, stone-cill adaptors, odd-leg adaptors, drip bars and thermal barriers.



## Thresholds

A full range of thresholds to suit every type of door is available, including outwards opening, dual operation, sub cill and Document "M" compliant low thresholds. Associated ancillaries such as infill bars, end cleats, seals and connectors are also available.

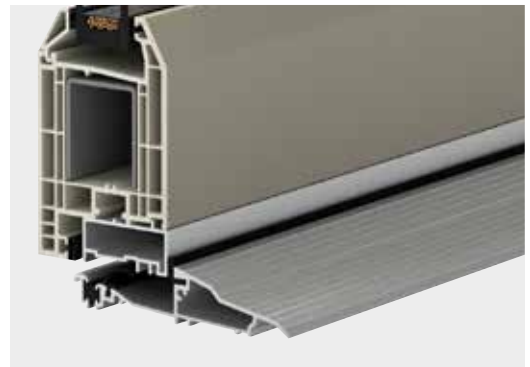

# The Colour Collection

Our Colour Collection brings a wealth of design flexibility to every project.

It features an array of shades from modern classics such as Anthracite Grey and heritage hues such as Chartwell Green to the palettes of the future such as Claystone. Dual colour options are also available, bringing the option of different interior and exterior colours. Profiles are wrapped in our state-of-the-art colour production facility to ensure the quality of finish remains pristine.

## Base appeal

To maximise your product choice further, we also offer complementary base colours on our foiled ranges to deliver higher-value aesthetics. These include white, grey, brown, tan and cream and are designed to perfectly complement our foils and deliver the next level in coloured profile aesthetics.

## Stock Colours

### Premium



Anthracite Grey /  
White (PVC-U)  
(White Base)



Anthracite Grey /  
Anthracite Grey  
(Grey Base)



Rosewood /  
White (PVC-U)  
(White Base)



Rosewood /  
Rosewood  
(Brown Base)



Black Brown /  
White (PVC-U)  
(White Base)



Black Brown /  
Black Brown  
(Brown Base)



Light Oak /  
White (PVC-U)  
(White Base)



Light Oak /  
Light Oak  
(Tan Base)

### Premium Plus



Cream /  
White (PVC-U)  
(White Base)



Cream /  
Cream  
(Cream Base)



White Woodgrain /  
White Woodgrain  
(White Base)

## Fast Track Colours

### Premium



Anthracite Grey Smooth /  
White (PVC-U)  
(White Base)



Anthracite Grey Smooth /  
Anthracite Grey Smooth  
(Grey Base)



Chartwell Green/  
White (PVC-U)  
(White Base)



Agate Grey/  
White (PVC-U)  
(White Base)



Slate Grey/  
White (PVC-U)  
(White Base)

### Premium Plus



Pebble Grey /  
White (PVC-U)  
(White Base)



Claystone /  
White (PVC-U)  
(White Base)







Sage Smooth /  
White (PVC-U)  
(White Base)



## Made to Order Colours

Made to Order Colours are available with white PVC-U internal faces, or foiled on both sides on a complementary base colour for better looking installations.

Cream Base	Tan Base	Brown Base	White Base	Grey Base	
 Cream	 Irish Oak	 AnTeak	 White	 Black Ulti-Matt	 Slate Grey
 Claystone	 Honey Oak Super-Matt*	 Swamp Oak	 Dark Red	 Silver D Smooth*	 Anthracite Grey
 Pebble Grey	 Light Oak	 Rosewood	 Steel Blue	 Hazy Grey	 Anthracite Grey Smooth
 Windsor	 Pyrite	 Black Brown	 Dark Green	 Kensington Grey	
 Sage Smooth		 Flemish Gold Smooth*		 Buckingham Grey	
 Agate Grey				 Basalt Grey Smooth	
 Chartwell Green				 Slate Grey Finesse	



# Safeware hardware range

Safeware is one of the UK's leading industry suppliers, offering a complete hardware range, including trusted household names like Yale.



## A multitude of benefits.

We know that quality hardware more than delivers return on investment in reduced call backs, maintenance and performance.

And when you order your hardware from us you can be confident that all products are compatible with Epwin Window Systems, putting an end to checking specifications or calling suppliers with queries.

You can order profiles and hardware on the same order and the same delivery. It streamlines admin, accounting and goods inwards processes and saves time.

Finally, Safeware's high stock levels and rapid delivery from our Telford warehouse mean there's no need to worry about product availability or delays to schedules.



# Spectus gives you peace of mind

As the UK's leading systems brand, Epwin Window Systems holds all the accreditations you need to meet your requirements.



**BS EN ISO 9001**  
BSI Registered firm scheme: Quality management systems - requirements.



**BS EN ISO 14001**  
Manufactured under an ISO14001 Registered Environmental Management System.



**BS EN ISO 45001**  
Occupational health and safety management systems.



**BS EN 12608 / PAS 24**  
Window System Supplier  
Enhanced security performance requirements for window assemblies.



**BS EN 12608 / PAS 24**  
Door System Supplier. General and enhanced security performance requirements for composite door assemblies.



**BS EN 12608**  
PVC-U Profiles for the fabrication of windows and doors assemblies.



**BS 8529 / PAS 24**  
Door System Supplier. General and enhanced security performance requirements for composite door assemblies.



**Secured by Design**  
The UK Police initiative supporting the principles of 'designing out crime' by use of crime prevention and security standards.



**VinylPlus**  
A labelling scheme to identify the most sustainable and high-performance PVC products.

## Tested to the highest standards

Every aspect of the Epwin Window Systems range is continually tested and assessed to ensure it offers excellence in every respect. All Spectus Bevelled System products meet current Building Regulations as standard and many can provide solutions far above these requirements. No matter how demanding your project, Spectus Bevelled System products will deliver.

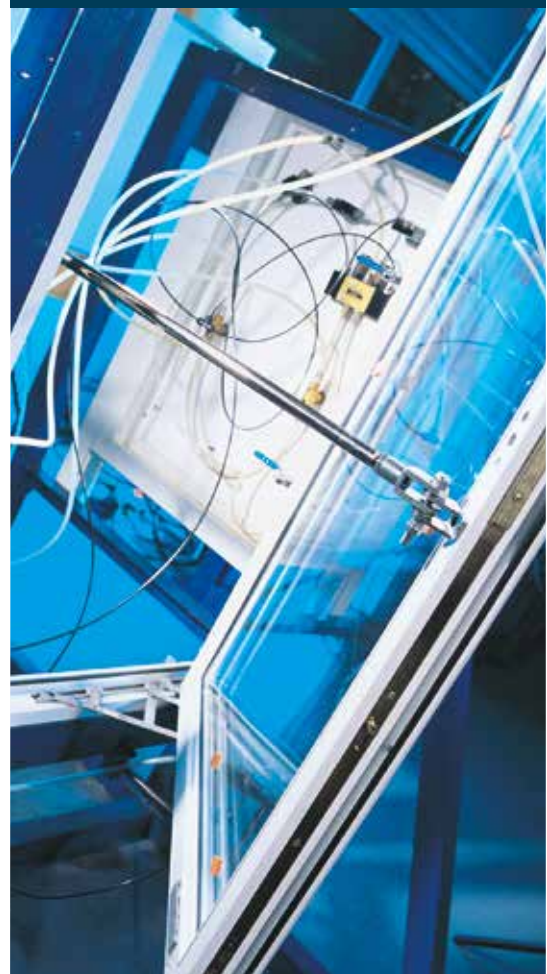

# Security benefits

Safety and security are designed into the Spectus Bevelled System.

The Spectus Bevelled System can accommodate the latest high-security hardware, meets the standards of PAS 24:2016, exceeds the requirements of Building Regulations and can be fabricated to meet Secured by Design criteria.

Specific safety features and adaptations are also a possibility – our technical experts are on hand to help you design exactly what's required.

**Secured by Design**



**Official Police Security Initiative**





# Thermal efficiency

Impressive thermal efficiency is easy with the Spectus Bevelled System.

The Spectus Bevelled System can achieve energy ratings up to band A++ and U-values of 0.8 W/m<sup>2</sup>K. Triple glazing is straightforward too. Our double/triple glazing to BS6262 can be supplied using 24-44mm insulating glass units depending on thermal and acoustic performance requirements.

With more options, it's easier to offer the exact WER specification your customer needs. You can even choose to combine double or triple glazing in the same project to make the best use of passive solar gain or to add extra insulation to rooms with large glass expanses.

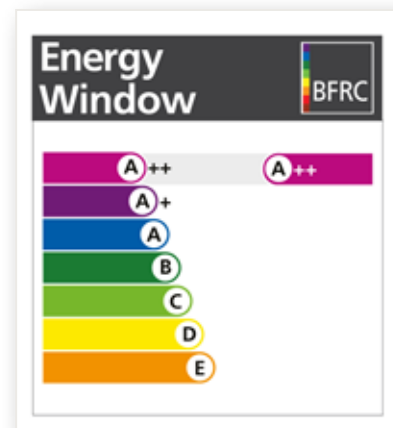

# Spectus Bevelled System Product Data



**Casement Window**



**French Casement Window**

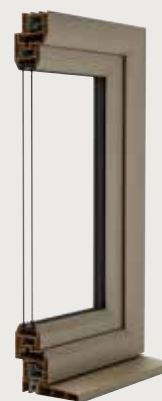

**Tilt & Turn Window**

PERFORMANCE & ACCREDITATION	Top Hung		Side Hung	
U-value (double glazing)	1.2 W/m <sup>2</sup> K		1.2 W/m <sup>2</sup> K	1.2 W/m <sup>2</sup> K
U-value (triple glazing)	0.8 W/m <sup>2</sup> K		0.8 W/m <sup>2</sup> K	0.8 W/m <sup>2</sup> K
Energy Rating (WER)	A++		A+	A++
Green Guide Rating #	A		A	A
Acoustic Performance-various options depending on specification-RW (C;Ctr)	41		41	37
Air Tightness (Pa)	Class 2 (300pa)	Class 3 (600pa)	N/A	Class 4 (600pa)
Water Tightness (Pa)	Class 9A (600pa)	Class 9A (600pa)	N/A	Class 7A (300pa)
Wind Loading (Pa)	Class A4 (1600pa)	Class A5 (2000pa)	N/A	Class A4 (1600pa)
Security	PAS 24		N/A	PAS 24
PAS 24 Size Limits (mm)	1240 x 1240	740 x 1340	N/A	1386 x 1500
Secured by Design (SBD)	✓			✓

## CONFIGURATIONS

Top Hung Outward	✓			
Side Hung Outward	✓		✓	
Fixed Light	✓		✓	✓
Multilight	✓		✓	✓
Tilt & Turn			✓	

## SASH WEIGHT & SIZE LIMITS

Maximum Sash Weight*	50 kg	40 kg	40 kg	130 kg
Maximum Sash Size (mm)	1240 x 1240	740 x 1340	740 x 1340	1426 X 1540

## SYSTEM FEATURES

System Depth (mm)	70	70	70	70
Multipoint Locking	✓	✓	✓	✓
Glazing Options	Internally & Externally Beaded	Internally & Externally Beaded	Internally & Externally Beaded	Internally Beaded
Glazing Thickness (mm)	24/28/36/40/44	24/28/36/40/44	24/28/36/40/44	24/28/36/40/44



**Residential  
Doors**



**French  
Doors**

PERFORMANCE & ACCREDITATION				
U-value (double glazing)	1.2 W/m <sup>2</sup> K		1.3 W/m <sup>2</sup> K	
U-value (triple glazing)	0.8 W/m <sup>2</sup> K		0.9 W/m <sup>2</sup> K	
Energy Rating (DSER)	A++		A+	
Green Guide Rating #	A		A	
Acoustic Performance-various options depending on specification-RW (C;Ctr)	41		41	
Air Tightness (Pa)	Class 3 (600Pa)	Class 2 (300Pa)	Class 3 (600Pa)	Class 2 (300Pa)
Water Tightness (Pa)	Class 5A (200Pa)	Class 5A (200Pa)	Class 3A (100Pa)	Class 2A (150Pa)
Wind Loading (Pa)	Class C4 (1600Pa)	Class C2 (800Pa)	Class A4 (1600Pa)	Class A3 (1200Pa)
Security	PAS 24		PAS 24	
PAS 24 Size Limits (mm)	950 x 2100	1000 x 2151	963 x 2056	1000 x 2151
Secured by Design (SBD)	✓		✓	
CONFIGURATIONS				
Single Door	✓			
Double Door			✓	
Fixed Light	✓		✓	
SASH WEIGHT & SIZE LIMITS				
Maximum Sash Weight*	120 kg		120 kg	
Maximum Sash Size (mm)	1000 x 2200		1000 x 2200	
SYSTEM FEATURES				
System Depth (mm)	70		70	
Multipoint Locking	✓		✓	
Glazing Options	Internally Beaded		Internally Beaded	
Glazing Thickness (mm)	24/28/36/40/44		24/28/36/40/44	

\* Hardware dependent



For more information about Epwin Window Systems products visit  
[www.epwinwindowssystems.co.uk](http://www.epwinwindowssystems.co.uk)



**Epwin**<sup>™</sup>  
window systems

Epwin Window Systems is an international PVC-U profile system supplied to local independent manufacturers and installers who contract to install windows, doors and conservatories. Epwin Window Systems cannot be held accountable for manufacture or installation by independent companies. All information in this publication is provided for guidance only and is given in good faith. As it is company policy to continually improve products, methods and materials, changes of specification may be made from time to time without prior notice. This statement does not affect your statutory rights. © Epwin Window Systems. Part of the Epwin Group Plc. EWS/17506